

# Modeling and Prediction of Driver-Vehicle-Unit Velocity Using Adaptive Neuro-Fuzzy Inference System in Real Traffic Flow

*Iman Tahbaz-zadeh Moghaddam<sup>1</sup>, Moosa Ayati<sup>2\*</sup>*  
*School of Mechanical Engineering, College of Engineering,*  
*University of Tehran, Tehran, Iran*  
*\*Corresponding Author Email: m.ayati@ut.ac.ir*

*Amir Taghavipour<sup>3</sup>*  
*Department of Mechanical Engineering,*  
*K. N. Toosi University of Technology, Tehran, Iran*

*Javad Marzbanrad<sup>4</sup>*  
*School of Automotive Engineering,*  
*Iran University of Science and Technology, Tehran, Iran*

## ABSTRACT

*Prediction of the driver-vehicle-unit (DVU) future state is a challenging problem due to many dynamic factors influencing driver capability, performance and behavior. In this study, a soft computing method is proposed to predict the accelerating behavior of driver-vehicle-unit in the genuine traffic stream that is collected on the California urban roads by US Federal Highway Administration's NGSIM. This method is used to predict DVU velocity for different time-steps ahead using adaptive neuro-fuzzy inference system (ANFIS) predictor. To evaluate the performance of proposed method, standard time series forecasting approach called autoregressive (AR) model is considered as a rival method. The predictions accuracy of two methods are compared using root mean square error (RMSE), mean absolute percentage error (MAPE) and coefficient of determination or R-squared ( $R^2$ ) as three error criteria. The results demonstrate the adequacy of proposed algorithm on real traffic information and the predicted speed profile shows that ANFIS is able to predict the dynamic traffic changes. The proposed model can be employed in intelligent transportation systems (ITS), collision prevention systems (CPS) and etc.*

**Keywords:** *Traffic model; adaptive neuro-fuzzy inference system; velocity prediction; intelligent transportation systems.*

## **Introduction**

With the constantly growing number of vehicles across the world, improving the vehicle performance has become an ongoing objective for researchers and industrial companies in the automotive field [1]. However, the automotive companies produce vehicles with high performance; the one undesirable result is the high rate of accidents and number of injuries when collisions do happen [2]. For this reason, in recent years, driver assistance systems (DAS) are extensively used in perspective of the way that safety will be increased and driver remaining tasks at hand will be reduced in DAS-equipped vehicles [3]. These supporting systems increase comfort and performance for drivers in the undertaking of lateral and longitudinal vehicle control [4]. DAS applications continually scan the vehicle surroundings and also driving actions to identify possibly risky circumstances at a beginning stage. In critical driving situations these applications warn and effectively support the driver and, if it is need, get involved automatically with an end goal to keep vehicle away from a collision or to reduce the consequences of an accident [5].

To increase the safety of vehicles, it is critically important to understanding, analyzing and modeling human driver behavior [6]. In an investigation supported by NHTSA, it was found that driver mistakes was the major contributor in more than 90% of the crashes examined [7]. Also, it should be noticed that driving behaviors differ among different drivers. They differ in how they turn the steering wheel, in the manner in which they hit the gas and brake pedals, and what's more in how much distance they keep when following a vehicle [8]. Driver state, personality, experience, task demand and situation awareness are the five noteworthy classes of elements impacting driver capability, performance and behavior [9].

Researchers use microscopic data to analyze driving behavior, traffic impacts (instantaneous speeds, accelerations, car-following distances and relative speeds), calibration of traffic flow models and enhancing the ITS applications. So this data can be used to determine or to estimate safety measures like time-to-collision (TTC) [10]. In point of fact, to improve the functionality of the vehicle safety, intelligent tools should be utilized to predict the upcoming vehicle speed profiles with respect to the real-time speed trajectories of a moving vehicle [11]. For this purpose, several studies are investigated in recent years. Fotouhi et al. showed that intelligent tools like back propagation-artificial neural network (BP-ANN) can be employed to predict the time-series of vehicle speed [11]. Similar approach used for real time vehicle speed predictions considering driver characteristics in car-following scenarios [12]. In study [13], it is indicated that a fuzzy system is an

effective method for prediction of parallel hybrid electric vehicles (HEVs) speed profile. An integrated intelligence technique based on artificial neural network (ANN) and genetic algorithm (GA) improved in study [14] for predicting the driver's accelerating behavior in the stop and go maneuvers.

In this study, the ability of adaptive neuro-fuzzy inference system (ANFIS) for predicting driver-vehicle-unit (DVU) speed profile in real traffic flow is investigated. ANFIS is a hybrid-intelligent technique that showed a promising performance in different aspects of our life, and more widely in modeling the human mental activities and medical applications [15]. A neuro-fuzzy system is a combination of two major techniques: artificial neural networks and fuzzy logic. An artificial neural network is similar to human intelligence with ability of learning and adaptation; while the fuzzy logic is responsible for solving uncertainties like human logic with no limitations for decision making. One of the main applications of integrated neuro-fuzzy system is in black-box modeling using input/outputs of concerned systems [16]. This approach is employed in many studies for the main purposes of modeling, prediction and identification of systems [17]. The applications of ANFIS technique is addressed in [17] and [18] explicitly.

This paper is organized as follows. First, the importance of traffic modeling is explained and it is illustrated that how the real traffic data are collected and developed for the farther simulations. These data are obtained from NGSIM dataset which is provided by US Federal Highway Administration. Then, the procedure of designing ANFIS model to predict the DVU velocity in different time-steps ahead is illustrated. The simulation results and discussions for the proposed ANFIS model are given in the last section.

## **Modeling Microscopic Driving Behavior**

Microscopic driver behavior models have been growing in certain decades with the principle goal of simulating the movement of vehicles in traffic lanes through mathematical relations. In these models, vehicle movements and their interactions with other vehicles are derived by simulating traffic network infrastructure at every second through a couple of driving principles. These principles include car-following, passing maneuver, lane changing and the other driving maneuvers [10]. In this study, in order to simulate the speed profile of vehicles, which show microscopic behavior of these models, NGSIM real traffic dataset provided by US Federal Highway Administration [19] is utilized, which is illustrated in the next section.

### Collection and preparation of real traffic data

In order to design ANFIS predicator for modeling driving microscopic behavior, a dataset is needed. NGSIM data provides detailed vehicle time-to-time trajectory information, traffic information, and supporting information required for researching in driving behavior algorithms. One of these traffic dataset is I-80, which has been gathered at the Berkeley Highway Laboratory (BHL) in Emeryville by California Center for Innovative Transportation (CCIT) and Cambridge Systematics. A segment of eastbound I-80 in San Francisco Bay area is shown in Figure 1. Seven cameras recorded I-80 dataset and captured trajectories of 5648 vehicle in three intervals of 15 minutes (with resolution of 10 frames in each second) on a road section of approximately 500m as shown in Figure 2 [19].

Considering observations in real traffic are always affected by measurement errors, the data which is used to test the model should be smoothed like [20]. Thus, before any further data analysis, a moving average filter is designed as in Equation (1) and applied to all the needed traffic data. In Equation (1),  $U$  and  $V$  are original data and filtered data respectively, and  $k$  is length of window which contains data. In this way, all the DVU positioning data including trajectories of accelerations and velocities of vehicle that are extracted from video analysis are filtered by means of proposed filter. A comparison between the original and filtered acceleration data for a vehicle in one maneuver is shown in Figure 3. As shown in this figure, the original data contain large amount of noises with abnormal changes (e.g., time instant of 20-23 second); while the filtered one is more reliable and has acceptable variations. In study [21], the other filtering algorithms can be found for smoothing the NGSIM's raw data.

$$V[i] = \frac{1}{k} \sum_{j=0}^{k-1} U[i-j] \quad (1)$$

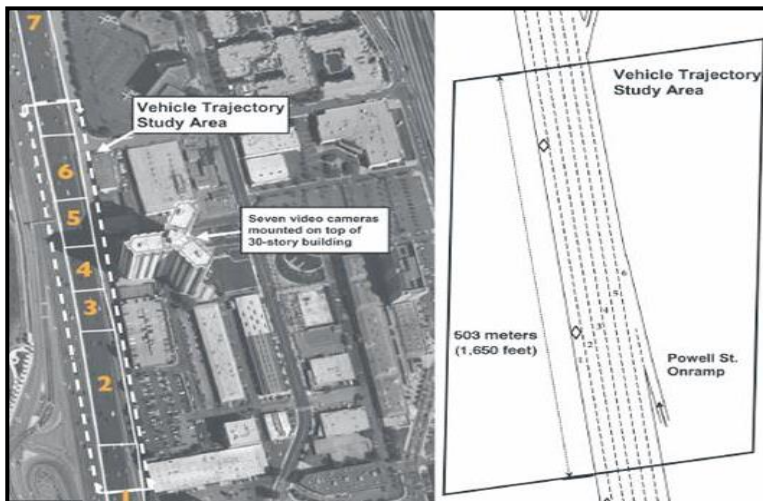

Figure 1: A segment of eastbound I-80 in San Francisco Bay area in California [19].



Figure 2: A video camera that overlooks I-80 is recording vehicle trajectory data [19].

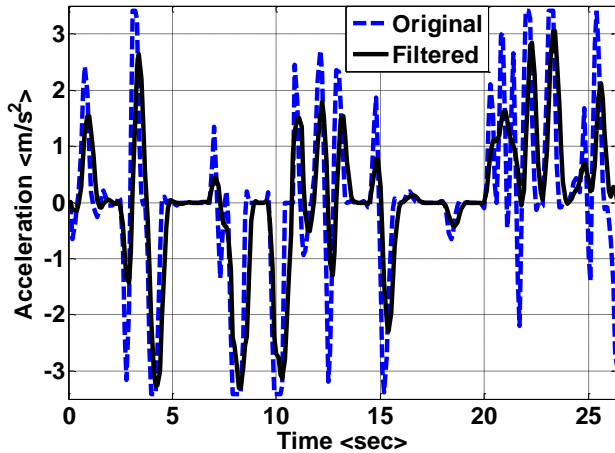

Figure 3: Comparison of original and filtered acceleration data for a vehicle in one maneuver.

### ANFIS Structure

In this section, the procedure of designing ANFIS model to predict DVU velocity time series, based on NGSIM data is illustrated. The ANFIS structure is developed by combining two approaches: artificial neural networks and fuzzy inference systems. By integrating these two intelligent approaches, both fuzzy reasoning and network calculation will be available simultaneously. The ANFIS is composed of two parts. The first is the antecedent part and the second is the conclusion part, which are connected to each other with the fuzzy rules base in network form. The structure of type-III ANFIS with two inputs and one output is shown in Figure 4. As shown in this figure, it is a five layer network that can be described as a multi-layered neural network [20]. The first layer is responsible to execute a fuzzification process, while the second layer executes the fuzzy AND of the antecedent part of the fuzzy rules. The third layer normalizes the membership functions (MFs), the fourth layer executes the conclusion part of the fuzzy rules, and the last layer computes the output of the fuzzy inference system by summing up the outputs of layer four. ANFIS has high ability of approximation that will depend on the resolution of the input space partitioning, which is determined by the number of MFs in the antecedent part for each input. The feed forward equations of the ANFIS structure with two inputs and one output are as in Equations (2-4):

$$w_{ij} = \mu_{A_i}(x) \times \mu_{B_j}(y); \quad i = 1,2; \quad j = 1,2 \quad (2)$$

$$\bar{w}_{ij} = \frac{w_{ij}}{\sum_{i=1}^2 \sum_{j=1}^2 w_{ij}}; \quad i = 1,2; \quad j = 1,2 \quad (3)$$

$$f_i = a_i x_1 + b_i x_2 + c_i, \quad i = 1,2,3,4 \quad (4)$$

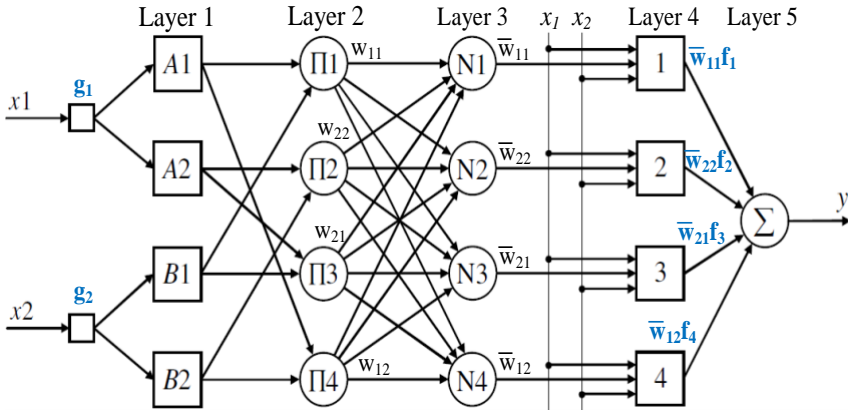

Figure 4: The structure of type-III ANFIS with two inputs and one output [22].

Where the values of  $\mu_A$  and  $\mu_B$  in Equation (2) represent the firing strength; also  $a_i$ ,  $b_i$  and  $c_i$  in Equation (4) are linear parameters of the ANFIS rules that are estimated using least squares algorithm. The overall output for the respective inputs within the fuzzy space is represented by Equation (5):

$$y = \bar{w}_{11}f_1 + \bar{w}_{22}f_2 + \bar{w}_{21}f_3 + \bar{w}_{12}f_4 \quad (5)$$

### Proposed predictor algorithm

In this study, the proposed ANFIS model has two inputs (i.e.  $x_1$  and  $x_2$  in Figure 4) and one output (i.e.  $y$  in Figure 4), which inputs are the velocity of vehicle at time-step  $i-1$  and  $i$  ( $v[i-1]$  and  $v[i]$ ), and the output of the model is the velocity of vehicle at time-step  $i+h$  ( $v[i+h]$ ), where  $h$  is step ahead. The proposed model will be trained to predict the DVU velocity prepared based on the NGSIM dataset in 1, 2 and 3 steps ahead using the DVU velocity in 2 steps ago, where each step is equal to 0.1 second. In other words, ANFIS model can predict the velocity of a DVU in 0.1, 0.2 and 0.3 seconds ahead based on the velocity of vehicle in instant time and 0.1 second ago. For developing the ANFIS

structure, two Gaussian-MF membership functions are chosen for each input (i.e.  $g_1$  and  $g_2$  functions in Figure 4) and Linear-MF types are chosen for the output (i.e.  $f_1$ - $f_4$  in Figure 4 and Equation 5). Also, the number of training iterations, initial step size, decrease rate of step size and increase rate of step size are set 500, 0.01, 0.9 and 1.1 respectively. In the developing process of ANFIS predictor, the available preformed data are separated into two subsets. The first part is the train and test dataset that is used for developing and calibrating the ANFIS model. In the training and test stages, the ANFIS structure including the layer weights (i.e.,  $w_{11}, w_{12}, w_{21}, w_{22}$ ) will be updated in each iteration to gain a better performance than the previous one. After finalizing the ANFIS architecture, the second data subset is used for validating the efficiency of the trained model. In this study, 70% of the main dataset is used for training and testing purposes and the remaining 30% is assigned for model validation. The input-output surface of the well-trained ANFIS model for predicting the DVU velocity in one step ahead is shown in Figure 5. By means of this surface, giving arbitrary inputs including  $v[i-1]$  and  $v[i]$  to the ANFIS model will lead to  $v[i+1]$ .

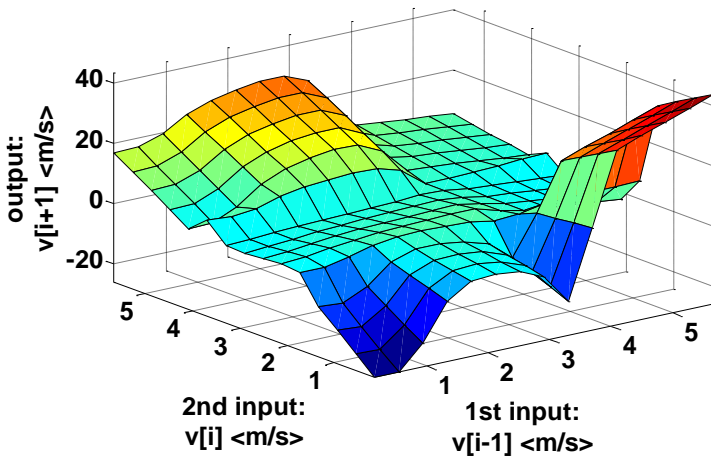

Figure 5: Input-output surface of the obtained ANFIS model.

## Results and Discussions

In order to evaluate the ANFIS model, the validation dataset, which was not employed in the stage of training ANFIS structure, will be used. Then a comparison between the prediction results of proposed model with real data and similar results of a well-known AR predictor model is investigated. It is worth mentioning that the data analysis using both the ANFIS and AR models is done in MATLAB software. The real and predicted values of proposed DVU



velocity time series for one maneuver in 1, 2 and 3 time-steps ahead (i.e. 0.1, 0.2 and 0.3 seconds ahead) are shown in Figure 6. Also, the absolute prediction error of both ANFIS and AR models are presented in Figure 7. The prediction results demonstrated in Figures 6 and 7 shows the high ability of ANFIS model for predicting the proposed DVU velocity time series in all time-steps ahead. For numerical assessment of the prediction accuracy, RMSE, MAPE and  $R^2$  criteria are applied as in Equations (6-8). In these equations,  $z_i$  shows the real value of the variable observed over  $N$  test observations,  $\hat{z}_i$  indicates the predicted value of variable obtained by employing proposed predictor, and  $\bar{z}_i$  is the mean value of the variable. Performance of the proposed predictor techniques considering three well-known error criteria are listed in Table 1 and also are demonstrated in bar graph in Figures 8-10.

$$RMSE = \sqrt{\frac{1}{N} \sum_{i=1}^N (z_i - \hat{z}_i)^2} \quad (6)$$

$$MAPE = \frac{100}{N} \sum_{i=1}^N \frac{|z_i - \hat{z}_i|}{z_i} \quad (7)$$

$$R^2 = 1 - \frac{\sum_{i=1}^N (z_i - \hat{z}_i)^2}{\sum_{i=1}^N (z_i - \bar{z}_i)^2} \quad (8)$$

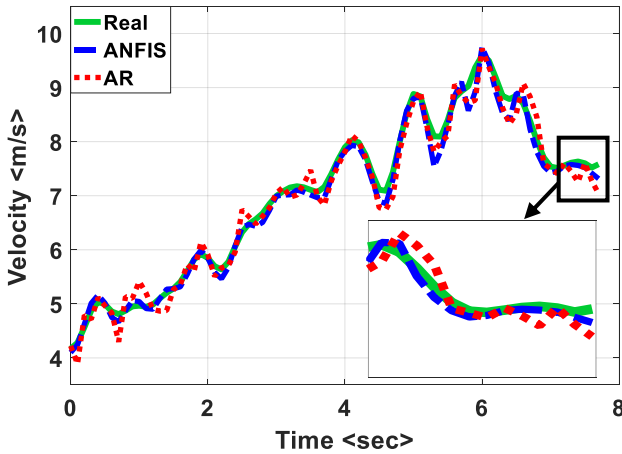

(a)

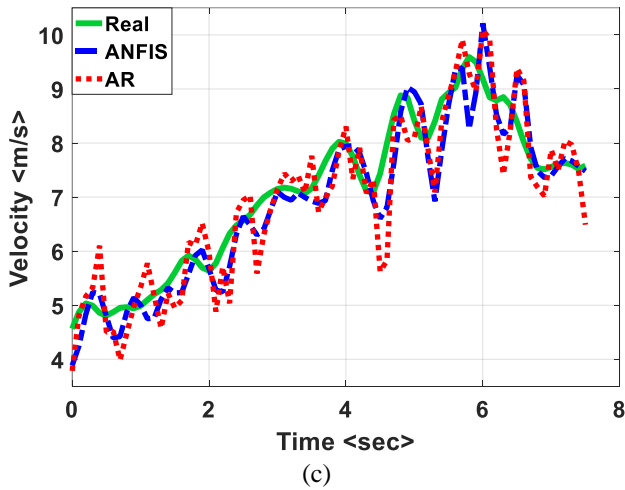
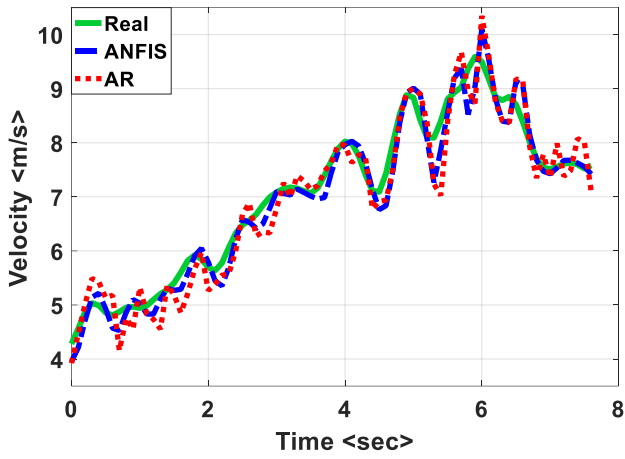
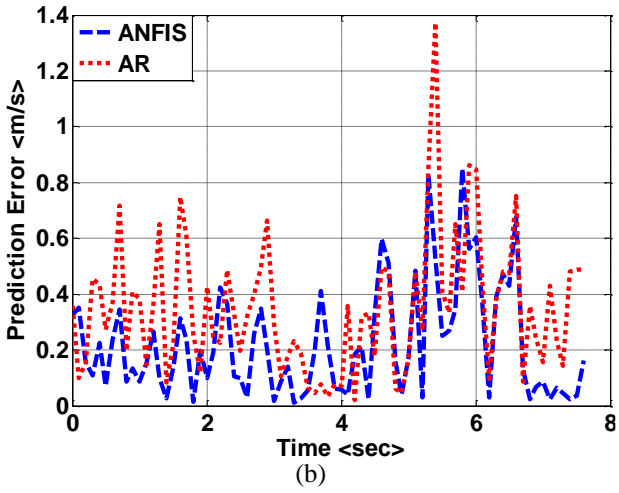
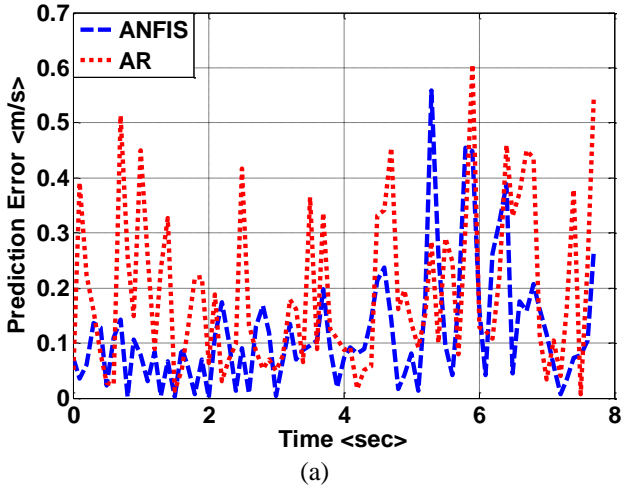

Figure 6: Velocity time series prediction based on ANFIS and AR models, (a) 0.1 second ahead, (b) 0.2 second ahead, (c) 0.3 second ahead.



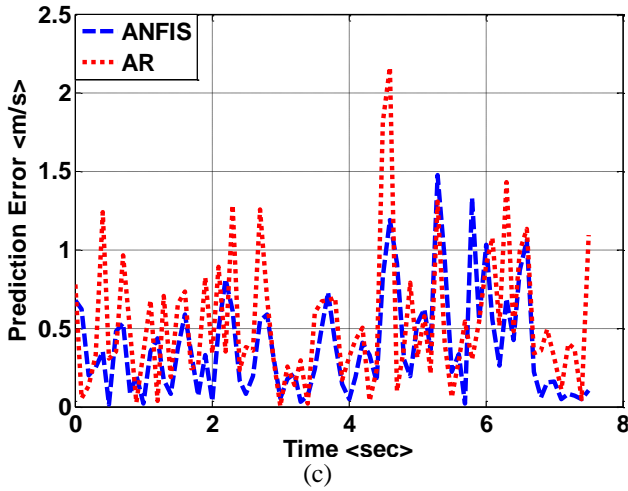

Figure 7: Comparison between ANFIS and AR prediction error, (a) 0.1 second ahead, (b) 0.2 second ahead, (c) 0.3 second ahead.

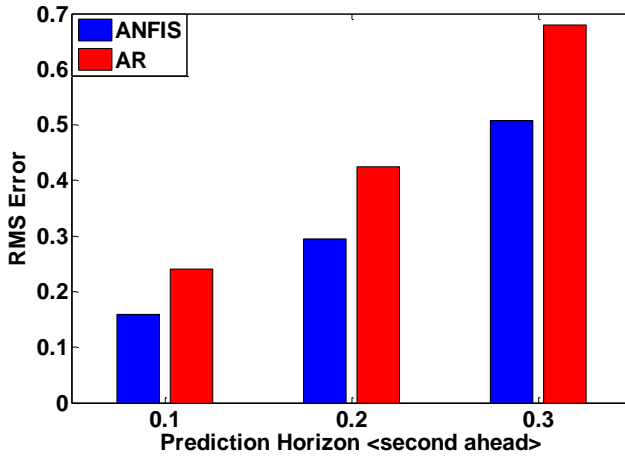

Figure 8: RMS Error for ANFIS and AR predictor models.

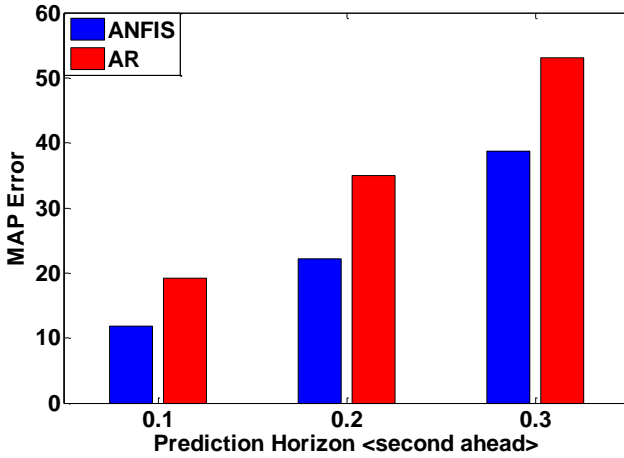

Figure 9: MAP Error for ANFIS and AR predictor models.

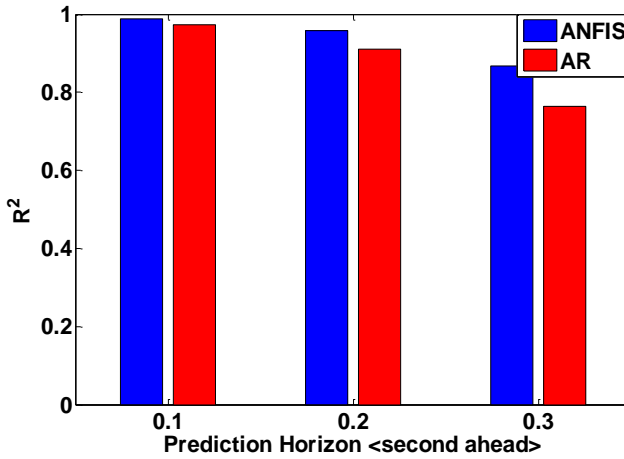

Figure 10: R<sub>2</sub> criterion for ANFIS and AR predictor models.

Table 1: Performance comparison of ANFIS and AR predictors according to RMS Error, MAP Error and R<sub>2</sub> criteria

Prediction Horizon	RMS Error		MAP Error		R <sub>2</sub>	
	ANFIS	AR	ANFIS	AR	ANFIS	AR
0.1 second ahead	0.15	0.24	11.7	19.2	0.982	0.971
0.2 second ahead	0.29	0.42	22.1	34.9	0.954	0.918

0.3 second ahead	0.50	0.67	38.7	53.1	0.862	0.764
------------------	------	------	------	------	-------	-------

Results presented in Table 1 show the successful performance of the ANFIS to predict DVU velocity in comparison with AR model. Also, it is concluded that the values of RMSE and MAPE are increasing directly by the prediction horizon for both designed predictors. Presented results in Figures 8, 9 and 10 show that there is a small difference between the prediction performances of ANFIS and AR for 0.1 second ahead; but for longer prediction horizons, the ANFIS predicts better than AR model which is in agree with the previous results.

To investigate the distributions of prediction errors provided by ANFIS and AR models, the histogram of prediction errors are illustrated in Figure 11. It should be noticed that the entire bar heights in the concerned histogram are normalized corresponding to their probability. In this way, the height of each bar will be equal to the probability of selected observation, and thus the sum of height of all bars for each individual model (e.g. ANFIS and AR) is equal to 1. According to Figure 11 and agree with the obtained results indicated in Table 1, deviation of prediction errors from zero for the ANFIS model is less than the AR one for all the prediction horizons.

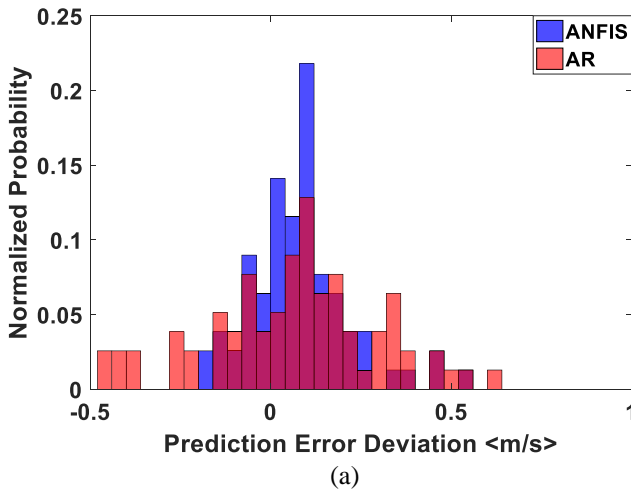

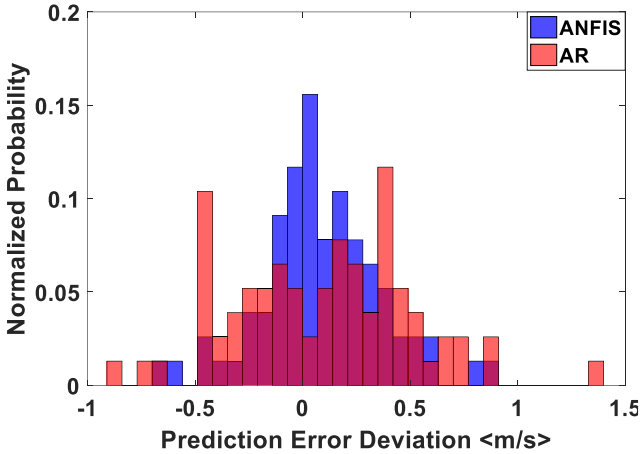

(b)

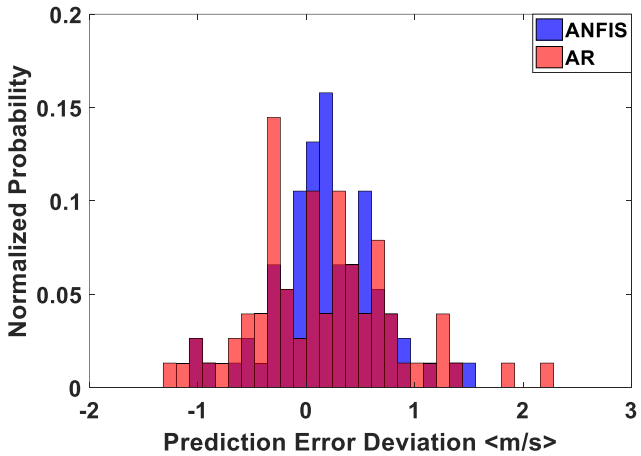

(c)

Figure 11: Distributions of velocity time series prediction error based on ANFIS and AR models, (a) 0.1 second ahead, (b) 0.2 second ahead, (c) 0.3 second ahead.

To point out the amount of uncertainty in predicting DVU velocity trajectories during different simulations, Figure 12 summarizes the average values of prediction errors obtained with different train and test dataset. The values represented are mean values acquired over twenty-fold crossvalidation and error bars shows dispersion of values about the mean. According to Figure

12, it is concluded that ANFIS model provides more accurate predictions with higher repeatability than AR one.

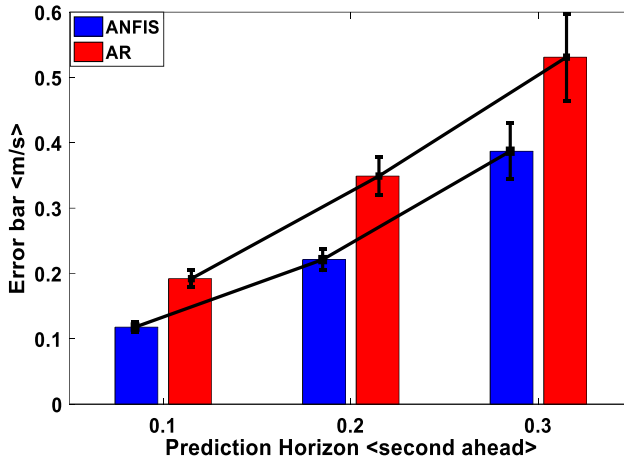

Figure 12: Error bar over twenty-fold crossvalidation in simulating DVU velocity trajectories for both ANFIS and AR models.

## Conclusions

Modeling and prediction of driver-vehicle-unit velocity in deferent time-steps ahead was investigated in this study. For this purpose, ANFIS predictor which combines two intelligent approaches of neural networks and fuzzy systems designed and trained. To assess the performance of proposed algorithm, real traffic dataset based on the US Federal Highway Administration’s NGSIM considered. ANFIS model predicts the DVU velocity in 1, 2 and 3 steps ahead, where each step is equal to 0.1 second. To evaluate predictions accuracy three criteria including RMSE, MAPE and  $R^2$  utilized and the performance of ANFIS compared with standard time series forecasting approach AR. Simulation results illustrate that the ANFIS model improves the prediction accuracy of DVU velocity profile in comparison with AR model and is highly accordant with real behaviors. The outcome of this study can be used in intelligent transportation systems, collision prevention systems and driver assistant systems which improve driving comfort, safety and reduce the danger of collisions. Also, the utilization of proposed method can be considered for further improvement of vehicle control strategies.

## Acknowledgment

The authors extend their thanks to the Next Generation Simulation (NGSIM) for providing the dataset used in this paper.



## References

- [1] P. Chena and Y. Min, “Automobile longitudinal axis detection method based on image segmentation and preliminary results”. *Jordan J. Mech. Ind. Eng.* 8 (5), pp. 297–303, 2014.
- [2] A. A. Alnaqia and A. S. Yigit, “Dynamic analysis and control of automotive occupant restraint systems”. *Jordan J. Mech. Ind. Eng.* 5 (1), pp. 39–46, 2011.
- [3] J. Marzbanrad and N. Karimian, “Space control law design in adaptive cruise control vehicles using model predictive control”. *Proc. Inst. Mech. Eng. Part D J. Automob. Eng.* 225, pp. 870–884, 2011.
- [4] J. Marzbanrad and I. Tahbaz-zadeh Moghaddam, “Self-tuning control algorithm design for vehicle adaptive cruise control system through real-time estimation of vehicle parameters and road grade”. *Veh. Syst. Dyn.* 54 (9), pp. 1291–1316, 2016.
- [5] IRU Commission on Road Safety, “IRU position on road safety related advanced driver assistance systems (ADAS)”. 2013.
- [6] P. Boyraz, A. Sathyanarayana and J. H. L. Hansen, “Driver behavior modeling using hybrid dynamics systems for ‘driver-aware’ active vehicle safety”. *Proceedings of the 21st (ESV) International Technical Conference on the enhanced safety of vehicles*, Stuttgart, Germany, 2009.
- [7] D. L. Hendricks, V. Engineering, M. Freedman, P. L. Zador, J. C. Fell, S. Mountain, J. F. Page, E. S. Bellis, T. G. Scheifflee, S. L. Hendricks, G. V. Steinberg and K. C. Lee, “The relative frequency of unsafe driving acts in serious traffic crashes”, *U.S. Department of Transportation, National Highway Traffic Safety Administration*, 2001.
- [8] C. Miyajima, Y. Nishiwaki, K. Ozawa, T. Wakita, K. Itou, K. Takeda and F. Itakura, “Driver modeling based on driving behavior and its evaluation in driver identification”. *Proceedings of the IEEE* 95 (2), pp. 427–437, 2007.
- [9] P. C. Cacciabue and O. Carsten, “A simple model of driver behaviour to sustain design and safety assessment of automated systems in automotive environments”. *Appl. Ergon.* 41 (2), pp. 187–197, 2010.
- [10] F. Viti, S. P. Hoogendoorn, H. J. Van Zuylen, I. R. Wilmlink and B. Van Arem, “Microscopic data for analyzing driving behavior at traffic signals”. *Traffic Data Collect. and its Stand.* 144, pp. 171–191, 2010.
- [11] A. Fotouhi, M. Montazeri-Gh, and M. Jannatipour, “Vehicle’s velocity time series prediction using neural network”. *Int. J. Automot. Eng.* 1 (1), pp. 21–28, 2011.
- [12] J. Park, D. Li, Y. L. Murphey, J. Kristinsson, R. McGee, M. Kuang and T. Phillips, “Real time vehicle speed prediction using a neural

- network traffic model”. *The International Joint Conference on Neural Networks*, San Jose, CA, USA, 2011.
- [13] H. Shu, L. Deng, P. He and Y. Liang, “Speed prediction of parallel hybrid electric vehicles based on fuzzy theory”. *International Conference on Power and Energy Systems*, Pune, India, 2012.
- [14] J. Marzbanrad and I. Tahbaz-zadeh Moghaddam, “Prediction of driver’s accelerating behavior in the stop and go maneuvers using genetic algorithm-artificial neural network hybrid intelligence”. *Int. J. Automot. Eng.* 5 (2), pp. 986–998, 2015.
- [15] B. Al-naami, M. A. Mallouh and E. A. Hafez, “Performance comparison of adaptive neural networks and adaptive neuro-fuzzy inference system in brain cancer classification”. *Jordan J. Mech. Ind. Eng.* 8 (5), pp. 305–312, 2014.
- [16] N. Arora and J. R. Saini, “A literature review on recent advances in neuro-fuzzy applications”. *International Journal of Advanced Networking Applications*, vol. 5, pp. 14-20, 2014.
- [17] J. R. Jang, “Neuro-fuzzy modeling for dynamic system identification”. *Fuzzy Systems Symposium, Soft Computing in Intelligent Systems and Information Processing*, 1996.
- [18] R. Babuska, “Neuro-Fuzzy Methods for Modeling and Identification”. *Recent Advances in Intelligent Paradigms and Applications. Part of the Studies in Fuzziness and Soft Computing book series*, vol 113, Physica, Heidelberg, 2003.
- [19] US Department of Transportation, “NGSIM - Next Generation Simulation”. <http://www.ngsim.fhwa.dot.gov>, 2009.
- [20] C. Thiemann, M. Treiber and A. Kesting, “Estimating acceleration and lane-changing dynamics based on NGSIM trajectory data”. *Transp. Res. Rec. J. Transp. Res. Board* 2088, pp. 90–101, 2008.
- [21] L. Li, X. Chen and L. Zhang, “A global optimization algorithm for trajectory data based car-following model calibration”. *Transp. Res. C, Emerg. Technol.*, vol. 68, pp. 311–332, 2016.
- [22] A. Ghaffari, A. Khodayari, F. Alimardani and H. Sadati, “MANFIS based modeling and prediction of the driver-vehicle unit behavior in overtaking scenarios”. *Int. J. Automot. Eng.* 3 (2), pp. 393–411, 2013.